

Prijslijst hoogwaardig koppel-en fitwerk, slangen PVDF, PPSU en RVS 316L insteekkoppelingen



RVS 316L opsteekkoppelingen

RVS 316L draadfittingen

FEP, PFA en PVDF slangen

Maart 2025

PVDF insteekkoppelingen

PVDF, Polyvinylideenfluoride, geschikt voor vele agressieve media.

Schroefdraden RVS 316L.

Afdichtingen FKM (FDA conform).

o.a. geschikt voor Voeding en Chemie.



Zie pagina 1

PPSU insteekkoppelingen

PPSU Polyfenylsulfon, geschikt voor vele media, tot 140°C (zie tabel voor details).

Schroefdraden PPSU / RVS 316L.

Afdichtingen FKM (FDA conform).

Zeer geschikt voor voeding, o.a. heet water, koffie, stoom enz.



Zie pagina 6

RVS 316L insteekkoppelingen

RVS 316L, geschikt voor vele agressieve media in zware omstandigheden.

Afdichtingen FKM (FDA conform).

Voor media tot 140°C (zie tabel voor details).

Geschikt voor Chemie, Pharma en Voeding.



Zie pagina 12

RVS 316L opsteekkoppelingen

RVS 316L, geschikt voor vele agressieve media in zware omstandigheden.

Messing vernikkelde of RVS316L moeren

Voor media tot 140°C.

Geschikt voor Chemie, Pharma en Voeding.



Zie pagina 19

RVS 316L Draadfittingen

RVS 316L, geschikt voor vele agressieve media in zware omstandigheden.

Voor media tot 140°C.

Geschikt voor Chemie, Pharma en Voeding.

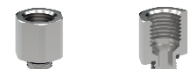

Zie pagina 25

FEP, PFA en PVDF slangen

Zeer grote chemische bestendigheid

Geschikt voor hoge temperaturen



Zie pagina 28

INDUSER bv

Hoofdweg 168-170

2908 LC Capelle aan den IJssel

Nederland

Tel: +31-(0)10-4588000

E-mail: info@induser.nl

Web: www.induser.nl

PVDF insteeker, plug

Maximale werkdruk bij omgevingstemperatuur tussen -20°C en +60°C: zie tabel

Aansluiting (mm):	Max druk (bar) bij medium temp.:			Type	Prijs (€)
	20°C	100°C	120°C		
4	16	16	10	971V-4	0,91
6	16	16	10	971V-6	1,10
8	16	12	10	971V-8	1,66
10	16	12	10	971V-10	2,56
12	12	6	3	971V-12	2,87
14	12	6	3	971V-14	3,18

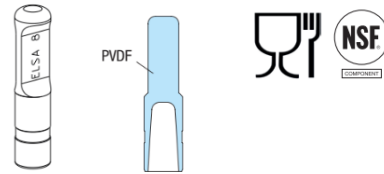

PVDF inschroefknie met RVS cilindrische schroefdraad met FKM o-ring (FDA)

Maximale werkdruk bij omgevingstemperatuur tussen -20°C en +60°C: zie tabel

Slang (mm):	Draad:	Max druk (bar) bij medium temp.:			Type:	Prijs (€)
		20°C	100°C	120°C		
4	M5	16	10	3	930V-4FF-M5	13,95
4	1/8	16	10	3	930V-4FF-1/8	12,00
4	1/4	16	10	3	930V-4FF-1/4	13,25
6	M5	16	10	3	930V-6FF-M5	13,92
6	1/8	16	10	3	930V-6FF-1/8	11,90
6	1/4	16	10	3	930V-6FF-1/4	13,27
8	1/8	16	8	3	930V-8FF-1/8	13,09
8	1/4	16	8	3	930V-8FF-1/4	14,29
8	3/8	16	8	3	930V-8FF-3/8	15,20
10	1/4	12	6	3	930V-10FF-1/4	16,25
10	3/8	12	6	3	930V-10FF-3/8	17,12
12	1/4	12	6	3	930V-12FF-1/4	24,69
12	3/8	12	6	3	930V-12FF-3/8	24,78

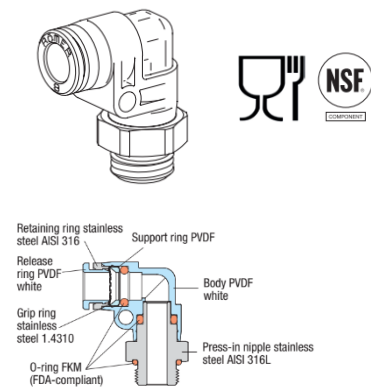

PVDF Knie insteeker

Maximale werkdruk bij omgevingstemperatuur tussen -20°C en +60°C: zie tabel

Slang (mm):	Stem (mm):	Max druk (bar) bij medium temp.:			Type:	Prijs (€)
		20°C	100°C	120°C		
4	4	16	10	3	911V-4FF-D4	6,47
4	6	16	10	3	911V-4FF-D6	6,60
6	4	16	10	3	911V-6FF-D4	6,64
6	6	16	10	3	911V-6FF-D6	6,64
6	8	16	8	3	911V-6FF-D8	7,40
8	8	16	8	3	911V-8FF-D8	7,44
8	10	16	8	3	911V-8FF-D10	9,72
10	10	12	6	3	911V-10FF-D10	10,49

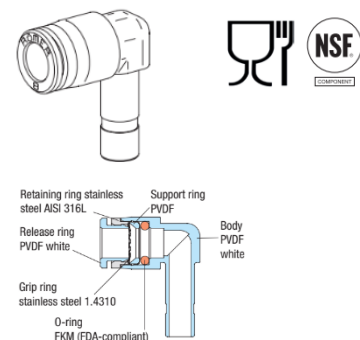

PVDF opschroefknie met RVS binnendraad, stelbaar

Maximale werkdruk bij omgevingstemperatuur tussen -20°C en +60°C: zie tabel

Slang (mm):	Draad:	Max druk (bar) bij medium temp.:			Type:	Prijs (€)
		20°C	100°C	120°C		
4	1/8	16	10	3	979V-4FF-1/8	12,00
4	1/4	16	10	3	979V-4FF-1/4	13,25
6	1/8	16	10	3	979V-6FF-1/8	11,90
6	1/4	16	10	3	979V-6FF-1/4	13,27
8	1/8	16	8	3	979V-8FF-1/8	13,09
8	1/4	16	8	3	979V-8FF-1/4	14,29

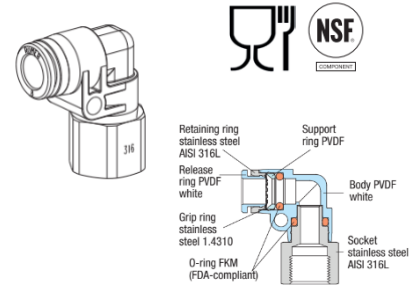

PVDF inschroef Tee met RVS cilindrische stelbare schroefdraad met FKM o-ring (FDA)

Maximale werkdruk bij omgevingstemperatuur tussen -20°C en +60°C: zie tabel

Slang (mm):	Draad:	Max druk (bar) bij medium temp.:			Type:	Prijs (€)
		20°C	100°C	120°C		
4	1/8	16	10	3	921V-4FF-1/8	15,25
4	1/4	16	10	3	921V-4FF-1/4	16,34
6	1/8	16	10	3	921V-6FF-1/8	15,11
6	1/4	16	10	3	921V-6FF-1/4	16,51
8	1/8	16	8	3	921V-8FF-1/8	16,75
8	1/4	16	8	3	921V-8FF-1/4	17,93
8	3/8	16	8	3	921V-8FF-3/8	18,73
10	1/4	12	6	3	921V-10FF-1/4	21,26
10	3/8	12	6	3	921V-10FF-3/8	22,24
12	1/4	12	6	3	921V-12FF-1/4	33,47
12	3/8	12	6	3	921V-12FF-3/8	33,57

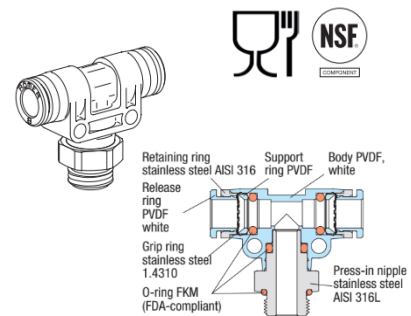

PVDF Tee insteker

Maximale werkdruk bij omgevingstemperatuur tussen -20°C en +60°C: zie tabel

Slang (mm):	Stem (mm):	Max druk (bar) bij medium temp.:			Type:	Prijs (€)
		20°C	100°C	120°C		
4	4	16	10	3	912V-4FF-D4	7,95
4	6	16	10	3	912V-4FF-D6	7,95
6	4	16	10	3	912V-6FF-D4	7,95
6	6	16	10	3	912V-6FF-D6	7,95
6	8	16	8	3	912V-6FF-D8	8,88
8	8	16	8	3	912V-8FF-D8	8,88
8	10	16	8	3	912V-8FF-D10	8,88
10	10	12	6	3	912V-10FF-D10	9,44

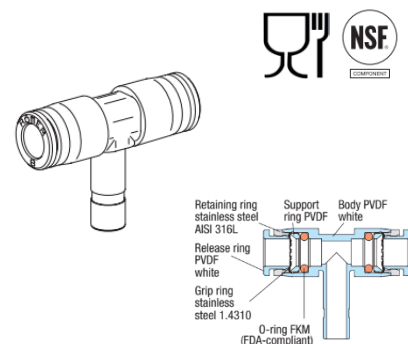

PVDF opschroef Tee met RVS binnendraad

Maximale werkdruk bij omgevingstemperatuur tussen -20°C en +60°C: zie tabel

Slang (mm):	Draad:	Max druk (bar) bij medium temp.:			Type:	Prijs (€)
		20°C	100°C	120°C		
4	1/8	16	10	3	970V-4FF-1/8	15,25
4	1/4	16	10	3	970V-4FF-1/4	16,34
6	1/8	16	10	3	970V-6FF-1/8	15,11
6	1/4	16	10	3	970V-6FF-1/4	16,51
8	1/8	16	8	3	970V-8FF-1/8	16,75
8	1/4	16	8	3	970V-8FF-1/4	17,93

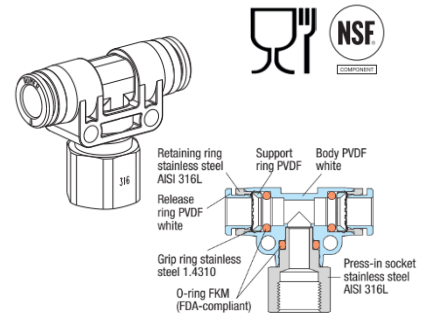

PVDF inschroef Zij-Tee met RVS cilindrische stelbare schroefdraad met FKM o-ring (FDA)

Maximale werkdruk bij omgevingstemperatuur tussen -20°C en +60°C: zie tabel

Slang (mm):	Draad:	Max druk (bar) bij medium temp.:			Type:	Prijs (€)
		20°C	100°C	120°C		
4	1/8	16	10	3	922V-4FF-1/8	15,25
4	1/4	16	10	3	922V-4FF-1/4	16,34
6	1/8	16	10	3	922V-6FF-1/8	15,11
6	1/4	16	10	3	922V-6FF-1/4	16,51
8	1/8	16	8	3	922V-8FF-1/8	16,75
8	1/4	16	8	3	922V-8FF-1/4	17,93
8	3/8	16	8	3	922V-8FF-3/8	18,73
10	1/4	12	6	3	922V-10FF-1/4	21,26
10	3/8	12	6	3	922V-10FF-3/8	22,24
12	1/4	12	6	3	922V-12FF-1/4	33,47
12	3/8	12	6	3	922V-12FF-3/8	33,57

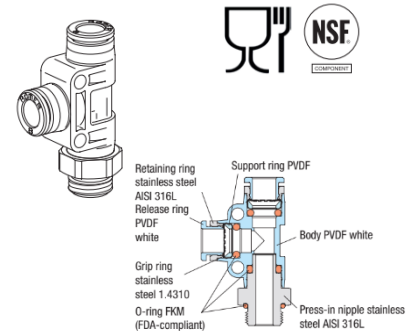

PVDF opschroef Zij-Tee met RVS binnendraad

Maximale werkdruk bij omgevingstemperatuur tussen -20°C en +60°C: zie tabel

Slang (mm):	Draad:	Max druk (bar) bij medium temp.:			Type:	Prijs (€)
		20°C	100°C	120°C		
4	1/8	16	10	3	923V-4FF-1/8	15,92
4	1/4	16	10	3	923V-4FF-1/4	17,07
6	1/8	16	10	3	923V-6FF-1/8	15,77
6	1/4	16	10	3	923V-6FF-1/4	17,23
8	1/8	16	8	3	923V-8FF-1/8	17,50
8	1/4	16	8	3	923V-8FF-1/4	18,71

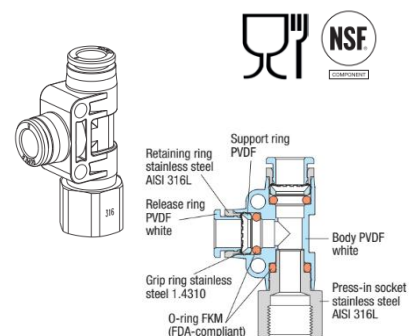

PVDF inschroef Y met RVS cilindrische stelbare schroefdraad met FKM o-ring (FDA)

Maximale werkdruk bij omgevingstemperatuur tussen -20°C en +60°C: zie tabel

Slang (mm):	Draad:	Max druk (bar) bij medium temp.:			Type:	Prijs (€)
		20°C	100°C	120°C		
4	1/8	16	10	3	992V-4FF-1/8	15,25
4	1/4	16	10	3	992V-4FF-1/4	16,34
6	1/8	16	10	3	992V-6FF-1/8	15,11
6	1/4	16	10	3	992V-6FF-1/4	16,51
8	1/8	16	8	3	992V-8FF-1/8	16,75
8	1/4	16	8	3	992V-8FF-1/4	17,93
8	3/8	16	8	3	992V-8FF-3/8	18,73
10	1/4	12	6	3	992V-10FF-1/4	21,26
10	3/8	12	6	3	992V-10FF-3/8	22,24
12	1/4	12	6	3	992V-12FF-1/4	33,47
12	3/8	12	6	3	992V-12FF-3/8	33,57

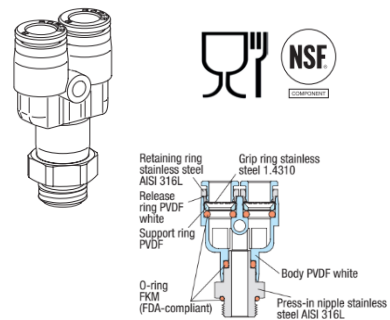

PVDF opschroef Y met RVS binnendraad

Maximale werkdruk bij omgevingstemperatuur tussen -20°C en +60°C: zie tabel

Slang (mm):	Draad:	Max druk (bar) bij medium temp.:			Type:	Prijs (€)
		20°C	100°C	120°C		
4	1/8	16	10	3	993V-4FF-1/8	15,92
4	1/4	16	10	3	993V-4FF-1/4	17,07
6	1/8	16	10	3	993V-6FF-1/8	15,77
6	1/4	16	10	3	993V-6FF-1/4	17,23
8	1/8	16	8	3	993V-8FF-1/8	17,50
8	1/4	16	8	3	993V-8FF-1/4	18,71

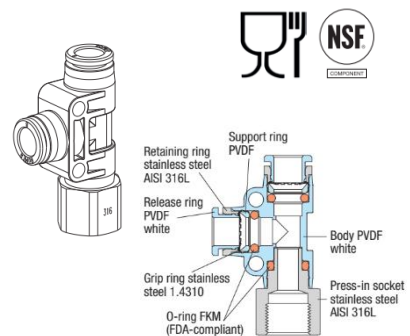

PVDF Rechte verbinder

Maximale werkdruk bij omgevingstemperatuur tussen -20°C en +60°C: zie tabel

Slang (mm):	Slang (mm):	Max druk (bar) bij medium temp.:			Type:	Prijs (€)
		20°C	100°C	120°C		
4	4	16	10	3	958V-4FF	7,24
6	4	16	10	3	958V-6-4FF	7,38
6	6	16	10	3	958V-6FF	7,43
8	6	16	8	3	958V-8-6FF	8,15
8	8	16	8	3	958V-8FF	8,19
10	8	12	6	3	958V-10-8FF	10,37
10	10	12	6	3	958V-10FF	11,53
12	10	12	6	3	958V-12-10FF	15,46
12	12	12	6	3	958V-12FF	16,70

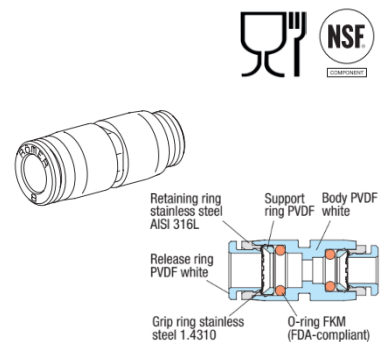

PVDF Tee verbinder

Maximale werkdruk bij omgevingstemperatuur tussen -20°C en +60°C: zie tabel

Slang (mm): Links- rechts	Slang (mm): midden	Max druk (bar) bij medium temp.:			Type:	Prijs (€)
		20°C	100°C	120°C		
4	4	16	10	3	954V-4FF	11,69
6	4	16	10	3	954V-6-4FF	11,83
6	6	16	10	3	954V-6FF	11,93
6	8	16	8	3	954V-6-8FF	12,89
8	6	16	8	3	954V-8-6FF	13,07
8	8	16	8	3	954V-8FF	13,21
10	6	12	6	3	954V-10-6FF	17,67
10	8	12	6	3	954V-10-8FF	17,37
10	10	12	6	3	954V-10FF	18,79
12	12	12	6	3	954V-12FF	25,94

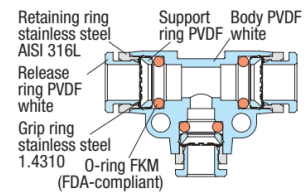
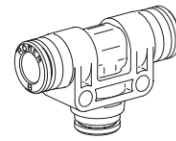

PVDF Y verbinder

Maximale werkdruk bij omgevingstemperatuur tussen -20°C en +60°C: zie tabel

Slang (mm): Links- rechts	Slang (mm): midden	Max druk (bar) bij medium temp.:			Type:	Prijs (€)
		20°C	100°C	120°C		
4	4	16	10	3	982V-4FF	11,69
6	4	16	10	3	982V-6-4FF	11,83
6	6	16	10	3	982V-6FF	11,93
8	6	16	8	3	982V-8-6FF	13,07
8	8	16	8	3	982V-8FF	13,21
10	8	12	6	3	982V-10-8FF	17,67
10	10	12	6	3	982V-10FF	18,79
12	12	12	6	3	982V-12FF	25,94

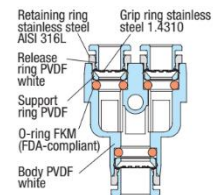

PVDF Rechte Schotdoorvoer verbinder

Maximale werkdruk bij omgevingstemperatuur tussen -20°C en +60°C: zie tabel

Slang (mm):	Slang (mm):	Max druk (bar) bij medium temp.:			Type:	Prijs (€)
		20°C	100°C	120°C		
4	4	16	10	3	959V-4FF	8,40
6	4	16	10	3	959V-6-4FF	8,68
6	6	16	10	3	959V-6FF	8,51
8	6	16	8	3	959V-8-6FF	9,48
8	8	16	8	3	959V-8FF	9,44
10	8	12	6	3	959V-10-8FF	11,96
10	10	12	6	3	959V-10FF	13,32

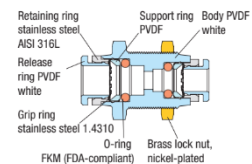
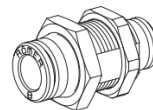

PPSU insteeker, plug

Maximale werkdruk bij omgevingstemperatuur tussen -20°C en +60°C: zie tabel

Aansluiting (mm):	Max druk (bar) bij medium temp.:			Type	Prijs (€)
	20°C	100°C	140°C		
4	20	16	10	971P3-4	1,04
6	20	16	10	971P3-6	1,19
8	16	12	10	971P3-8	1,76

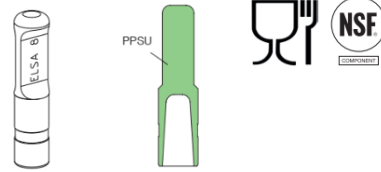

PPSU insteeker met slangpilaar

Maximale werkdruk bij omgevingstemperatuur tussen -20°C en +60°C: zie tabel

Insteker (mm):	Pilaar (mm):	Max druk (bar) bij medium temp.:			Type:	Prijs (€)
		20°C	100°C	140°C		
4	2,7-3	20	16	10	907P3-D4-3	1,11
4	3,5-4	20	16	10	907P3-D4-4	1,13
6	2,7-3	20	16	10	907P3-D6-3	1,17
6	3,5-4	20	16	10	907P3-D6-4	1,19
6	5-6	20	16	10	907P3-D6-7	1,59
6	7-8	20	16	10	907P3-D6-9	2,03

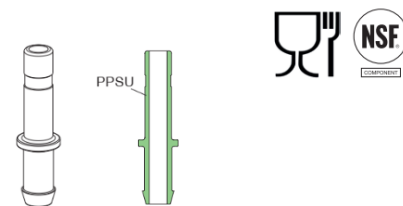

PPSU rechte inschroef koppeling met FKM o-ring (FDA)

Maximale werkdruk bij omgevingstemperatuur tussen -20°C en +60°C: zie tabel

Slang (mm):	Draad:	Max druk (bar) bij medium temp.:			Type:	Prijs (€)
		20°C	100°C	140°C		
4	1/8	20	16	10	951P3-4FF-1/8	5,75
4	1/4	20	16	10	951P3-4FF-1/4	6,10
6	1/8	20	16	10	951P3-6FF-1/8	5,83
6	1/4	20	16	10	951P3-6FF-1/4	6,04
8	1/4	16	12	6	951P3-8FF-1/4	6,00
8	3/8	16	12	6	951P3-8FF-3/8	6,32

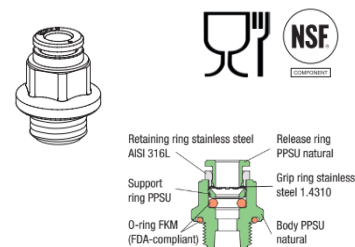

PPSU inschroefknie met RVS cilindrische schroefdraad met FKM o-ring (FDA)

Maximale werkdruk bij omgevingstemperatuur tussen -20°C en +60°C: zie tabel

Slang (mm):	Draad:	Max druk (bar) bij medium temp.:			Type:	Prijs (€)
		20°C	100°C	140°C		
4	M5	20	16	10	930P3-4FF-M5	14,35
4	1/8	20	16	10	930P3-4FF-1/8	14,01
4	1/4	20	16	10	930P3-4FF-1/4	15,38
6	M5	20	16	10	930P3-6FF-M5	14,30
6	1/8	20	16	10	930P3-6FF-1/8	13,85
6	1/4	20	16	10	930P3-6FF-1/4	15,22
8	1/8	16	12	6	930P3-8FF-1/8	20,00
8	1/4	16	12	6	930P3-8FF-1/4	19,88
8	3/8	16	12	6	930P3-8FF-3/8	21,02

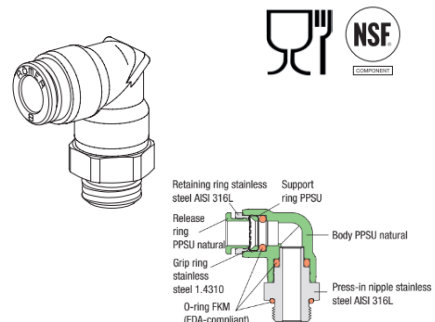

PPSU Knie insteeker

Maximale werkdruk bij omgevingstemperatuur tussen -20°C en +60°C: zie tabel

Slang (mm):	Stem (mm):	Max druk (bar) bij medium temp.:			Type:	Prijs (€)
		20°C	100°C	140°C		
4	4	20	16	10	911P3-4FF-D4	7,40
4	6	20	16	10	911P3-4FF-D6	7,26
6	4	20	16	10	911P3-6FF-D4	7,37
6	6	20	16	10	911P3-6FF-D6	7,15
6	8	16	12	6	911P3-6FF-D8	7,30
8	8	16	12	6	911P3-8FF-D8	7,16

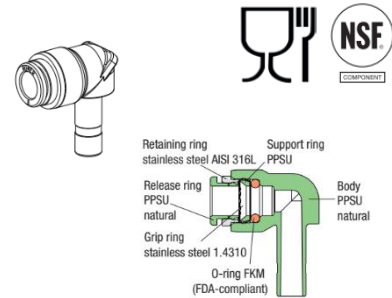

PPSU opschroefknie met RVS binnendraad, stelbaar

Maximale werkdruk bij omgevingstemperatuur tussen -20°C en +60°C: zie tabel

Slang (mm):	Draad:	Max druk (bar) bij medium temp.:			Type:	Prijs (€)
		20°C	100°C	140°C		
4	1/8	20	16	10	979P3-4FF-1/8	14,01
4	1/4	20	16	10	979P3-4FF-1/4	15,38
6	1/8	20	16	10	979P3-6FF-1/8	13,85
6	1/4	20	16	10	979P3-6FF-1/4	15,22
8	1/8	16	12	6	979P3-8FF-1/8	20,00
8	1/4	16	12	6	979P3-8FF-1/4	19,88

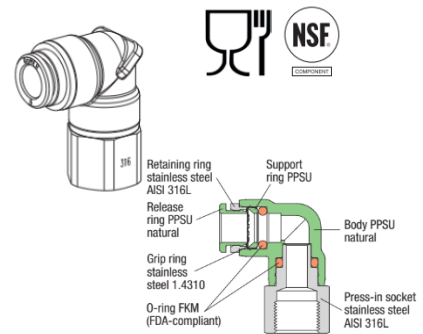

PPSU inschroef Tee met RVS cilindrische stelbare schroefdraad met FKM o-ring (FDA)

Maximale werkdruk bij omgevingstemperatuur tussen -20°C en +60°C: zie tabel

Slang (mm):	Draad:	Max druk (bar) bij medium temp.:			Type:	Prijs (€)
		20°C	100°C	140°C		
4	1/8	20	16	10	921P3-4FF-1/8	17,95
4	1/4	20	16	10	921P3-4FF-1/4	19,99
6	1/8	20	16	10	921P3-6FF-1/8	18,67
6	1/4	20	16	10	921P3-6FF-1/4	20,03
8	1/8	16	12	6	921P3-8FF-1/8	24,06
8	1/4	16	12	6	921P3-8FF-1/4	23,96
8	3/8	16	12	6	921P3-8FF-3/8	25,20

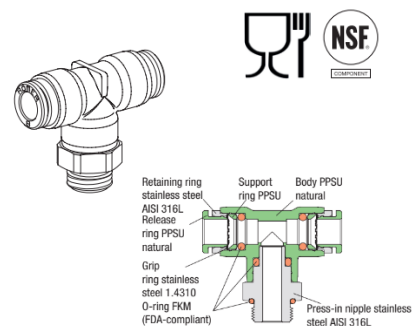

PPSU Tee insteker

Maximale werkdruk bij omgevingstemperatuur tussen -20°C en +60°C: zie tabel

Slang (mm):	Stem (mm):	Max druk (bar) bij medium temp.:			Type:	Prijs (€)
		20°C	100°C	140°C		
4	4	20	16	10	912P3-4FF-D4	9,78
4	6	20	16	10	912P3-4FF-D6	9,78
6	4	20	16	10	912P3-6FF-D4	9,85
6	6	20	16	10	912P3-6FF-D6	9,85
6	8	16	12	6	912P3-6FF-D8	10,04
8	8	16	12	6	912P3-8FF-D8	10,19

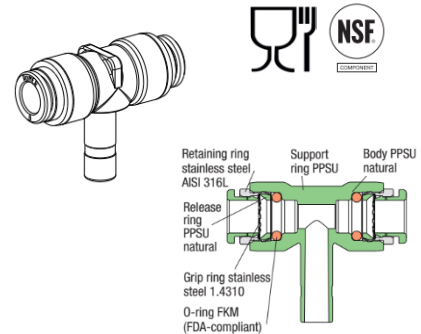

PPSU opschroef Tee met RVS binnendraad, stelbaar

Maximale werkdruk bij omgevingstemperatuur tussen -20°C en +60°C: zie tabel

Slang (mm):	Draad:	Max druk (bar) bij medium temp.:			Type:	Prijs (€)
		20°C	100°C	140°C		
4	1/8	20	16	10	970P3-4FF-1/8	17,95
4	1/4	20	16	10	970P3-4FF-1/4	19,99
6	1/8	20	16	10	970P3-6FF-1/8	18,67
6	1/4	20	16	10	970P3-6FF-1/4	20,03
8	1/8	16	12	6	970P3-8FF-1/8	24,06
8	1/4	16	12	6	970P3-8FF-1/4	23,96

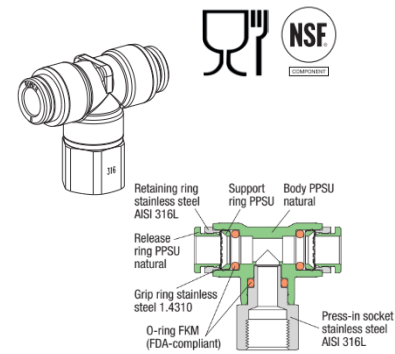

PPSU inschroef Zij-Tee met RVS cilindrische stelbare schroefdraad met FKM o-ring (FDA)

Maximale werkdruk bij omgevingstemperatuur tussen -20°C en +60°C: zie tabel

Slang (mm):	Draad:	Max druk (bar) bij medium temp.:			Type:	Prijs (€)
		20°C	100°C	140°C		
4	1/8	20	16	10	922P3-4FF-1/8	17,95
4	1/4	20	16	10	922P3-4FF-1/4	19,99
6	1/8	20	16	10	922P3-6FF-1/8	18,67
6	1/4	20	16	10	922P3-6FF-1/4	20,03
8	1/8	16	12	6	922P3-8FF-1/8	24,06
8	1/4	16	12	6	922P3-8FF-1/4	23,96
8	3/8	16	12	6	922P3-8FF-3/8	25,20

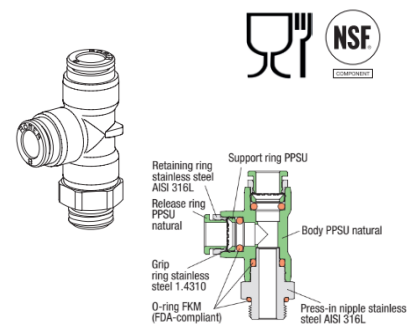

PPSU opschroef Zij-Tee met RVS binnendraad, stelbaar

Maximale werkdruk bij omgevingstemperatuur tussen -20°C en +60°C: zie tabel

Slang (mm):	Draad:	Max druk (bar) bij medium temp.:			Type:	Prijs (€)
		20°C	100°C	140°C		
4	1/8	20	16	10	923P3-4FF-1/8	17,95
4	1/4	20	16	10	923P3-4FF-1/4	19,99
6	1/8	20	16	10	923P3-6FF-1/8	18,67
6	1/4	20	16	10	923P3-6FF-1/4	20,03
8	1/8	16	12	6	923P3-8FF-1/8	24,06
8	1/4	16	12	6	923P3-8FF-1/4	23,96

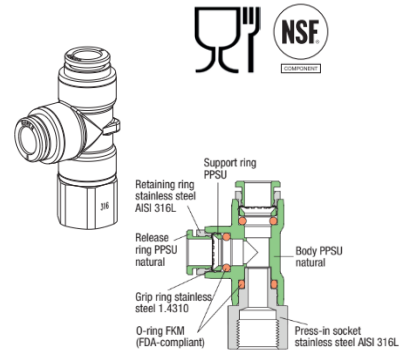

PPSU inschroef Y met RVS cilindrische stelbare schroefdraad met FKM o-ring (FDA)

Maximale werkdruk bij omgevingstemperatuur tussen -20°C en +60°C: zie tabel

Slang (mm):	Draad:	Max druk (bar) bij medium temp.:			Type:	Prijs (€)
		20°C	100°C	140°C		
4	1/8	20	16	10	992P3-4FF-1/8	17,95
4	1/4	20	16	10	992P3-4FF-1/4	19,99
6	1/8	20	16	10	992P3-6FF-1/8	18,67
6	1/4	20	16	10	992P3-6FF-1/4	20,03
8	1/8	16	12	6	992P3-8FF-1/8	24,06
8	1/4	16	12	6	992P3-8FF-1/4	23,96
8	3/8	16	12	6	992P3-8FF-3/8	25,20

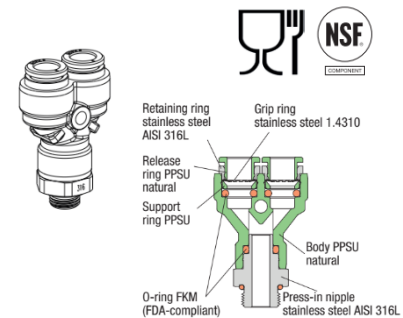

PPSU opschroef Y met RVS binnendraad, stelbaar

Maximale werkdruk bij omgevingstemperatuur tussen -20°C en +60°C: zie tabel

Slang (mm):	Draad:	Max druk (bar) bij medium temp.:			Type:	Prijs (€)
		20°C	100°C	140°C		
4	1/8	20	16	10	993P3-4FF-1/8	17,95
4	1/4	20	16	10	993P3-4FF-1/4	19,99
6	1/8	20	16	10	993P3-6FF-1/8	18,67
6	1/4	20	16	10	993P3-6FF-1/4	20,03
8	1/8	16	12	6	993P3-8FF-1/8	24,06
8	1/4	16	12	6	993P3-8FF-1/4	23,96

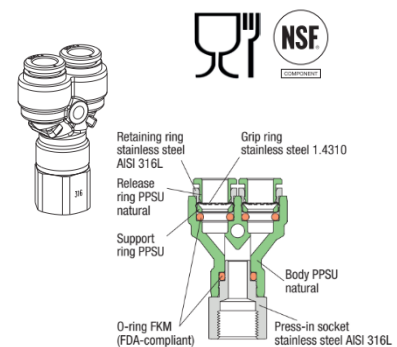

PPSU Rechte verbinder

Maximale werkdruk bij omgevingstemperatuur tussen -20°C en +60°C: zie tabel

Slang (mm):	Slang (mm):	Max druk (bar) bij medium temp.:			Type:	Prijs (€)
		20°C	100°C	140°C		
4	4	20	16	10	958P3-4FF	9,47
6	4	20	16	10	958P3-6-4FF	9,62
6	6	20	16	10	958P3-6FF	9,51
8	6	16	12	6	958P3-8-6FF	13,10
8	8	16	12	6	958P3-8FF	12,75

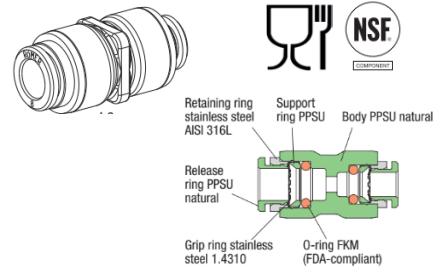

PPSU Knie verbinder

Maximale werkdruk bij omgevingstemperatuur tussen -20°C en +60°C: zie tabel

Slang (mm):	Slang (mm):	Max druk (bar) bij medium temp.:			Type:	Prijs (€)
		20°C	100°C	140°C		
4	4	20	16	10	955P3-4FF	9,93
6	4	20	16	10	955P3-6-4FF	10,08
6	6	20	16	10	955P3-6FF	9,85
8	6	16	12	6	955P3-8-6FF	13,43
8	8	16	12	6	955P3-8FF	12,97

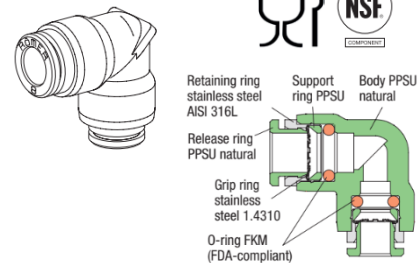

PPSU Tee verbinder

Maximale werkdruk bij omgevingstemperatuur tussen -20°C en +60°C: zie tabel

Slang (mm):	Slang (mm):	Max druk (bar) bij medium temp.:			Type:	Prijs (€)
		20°C	100°C	140°C		
Links-rechts	midden	20°C	100°C	140°C		
4	4	20	16	10	954P3-4FF	13,39
6	4	20	16	10	954P3-6-4FF	13,74
6	6	20	16	10	954P3-6FF	13,65
6	8	16	12	6	954P3-6-8FF	17,85
8	6	16	12	6	954P3-8-6FF	17,85
8	8	16	12	6	954P3-8FF	17,60
10	8	16	12	6	954P3-10-8FF	22,53
10	10	16	12	6	954P3-10FF	22,79

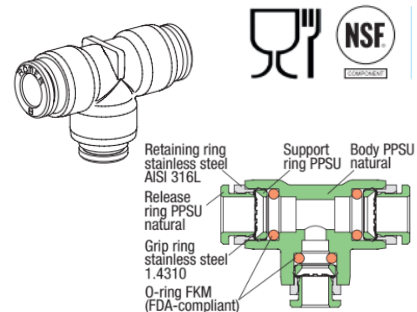

PPSU Y verbinder

Maximale werkdruk bij omgevingstemperatuur tussen -20°C en +60°C: zie tabel

Slang (mm):	Slang (mm):	Max druk (bar) bij medium temp.:			Type:	Prijs (€)
		20°C	100°C	140°C		
Links-rechts	midden	20°C	100°C	140°C		
4	4	20	16	10	982P3-4FF	13,04
6	4	20	16	10	982P3-6-4FF	13,53
6	6	20	16	10	982P3-6FF	13,30
8	6	16	12	6	982P3-8-6FF	18,41
8	8	16	12	6	982P3-8FF	17,95

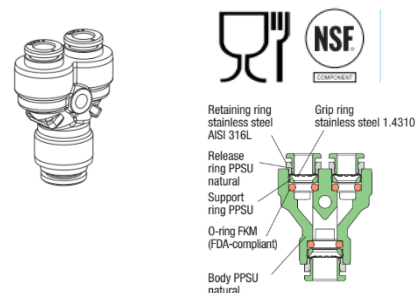

PPSU dubbele Y verbinder

Maximale werkdruk bij omgevingstemperatuur tussen -20°C en +60°C: zie tabel

Slang (mm):	Slang (mm):	Max druk (bar) bij medium temp.:			Type:	Prijs (€)
		20°C	100°C	140°C		
4 stuks	1 x midden					
6	6	20	16	10	984P3-6FF	41,98
8	6	16	12	6	984P3-8-6FF	42,34

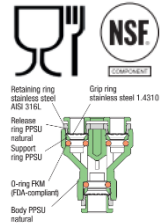

PPSU Rechte Schotdoorvoer verbinder

Maximale werkdruk bij omgevingstemperatuur tussen -20°C en +60°C: zie tabel

Slang (mm):	Slang (mm):	Max druk (bar) bij medium temp.:			Type:	Prijs (€)
		20°C	100°C	140°C		
4	4	20	16	10	959P3-4FF	10,96
6	6	20	16	10	959P3-6FF	11,11
8	8	16	12	6	959P3-8FF	12,38

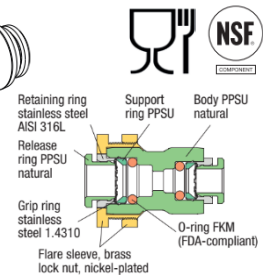
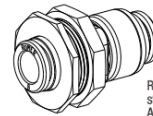

PPSU Kruis verbinder

Maximale werkdruk bij omgevingstemperatuur tussen -20°C en +60°C: zie tabel

Slang (mm):	Max druk (bar) bij medium temp.:			Type:	Prijs (€)
	20°C	100°C	140°C		
4	20	16	10	960P3-4FF	17,89
6-4	20	16	10	960P3-6-4FF	19,40
8	20	16	10	960P3-6FF	20,94

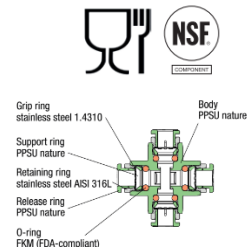
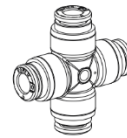

Rechte RVS inschroefkoppeling, cilindrische schroefdraad met FKM o-ring (FDA)

PN 20 bar, T_{max}140°C

Slang (mm)	Draad	Type	Prijs (€)
4	M5	951X44-4FF-M5	12,72
4	1/8"	951X44-4FF-1/8	12,41
4	1/4"	951X44-4FF-1/4	12,60
6	M5	951X44-6FF-M5	13,38
6	1/8"	951X44-6FF-1/8	12,99
6	1/4"	951X44-6FF-1/4	13,36
6	3/8"	951X44-6FF-3/8	14,89
8	1/8"	951X44-8FF-1/8	13,07
8	1/4"	951X44-8FF-1/4	13,74
8	3/8"	951X44-8FF-3/8	16,04
10	1/4"	951X44-10FF-1/4	17,10
10	3/8"	951X44-10FF-3/8	18,67
10	1/2"	951X44-10FF-1/2	22,84
12	1/4"	951X44-12FF-1/4	23,92
12	3/8"	951X44-12FF-3/8	27,07
12	1/2"	951X44-12FF-1/2	30,95

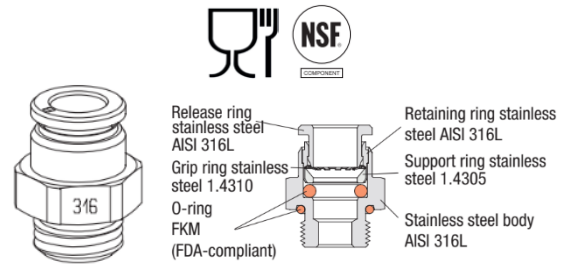

Rechte RVS inschroefkoppeling, conische schroefdraad

PN 20 bar, T_{max}140°C

Slang (mm)	Draad	Type	Prijs (€)
4	1/8"	951X44-4FF-1/8K	12,45
4	1/4"	951X44-4FF-1/4K	12,78
6	1/8"	951X44-6FF-1/8K	12,53
6	1/4"	951X44-6FF-1/4K	12,89
8	1/8"	951X44-8FF-1/8K	13,27
8	1/4"	951X44-8FF-1/4K	13,36
8	3/8"	951X44-8FF-3/8K	15,52
10	1/4"	951X44-10FF-1/4K	15,95
10	3/8"	951X44-10FF-3/8K	17,38
10	1/2"	951X44-10FF-1/2K	20,35
12	1/4"	951X44-12FF-1/4K	22,44
12	3/8"	951X44-12FF-3/8K	25,73
12	1/2"	951X44-12FF-1/2K	29,39

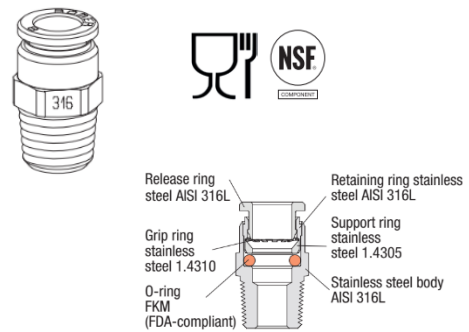

Rechte RVS Insteker, verkleiner

PN 20 bar, T_{max}140°C

Verkleining (mm-mm)	Type	Prijs (€)
6-4	947X44-4FF-D6	11,13
8-6	947X44-6FF-D8	11,97
10-8	947X44-8FF-D10	13,66
12-10	947X44-10FF-D12	15,57
8-4	947X44-4FF-D8	11,83
10-6	947X44-6FF-D10	12,65
12-8	947X44-8FF-D12	14,51

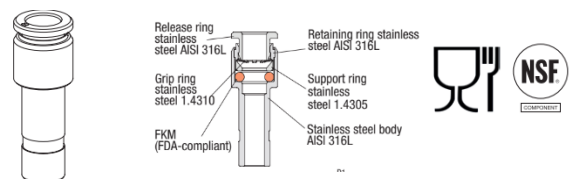

Y RVS koppeling
PN 20 bar, T_{max} 140°C

Slang (mm)	Type	Prijs (€)
4	982X44M-4FF	30,87
6	982X44M-6FF	37,17
8	982X44M-8FF	48,80
10	982X44M-10FF	59,94
12	982X44M-12FF	87,34

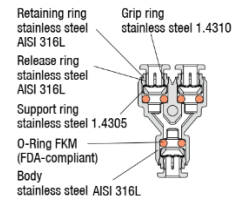

Y RVS inschroefkoppeling, stelbare cilindrische schroefdraad met FKM o-ring (FDA)
PN 16 bar, T_{max} 140°C

Slang (mm)	Draad	Type	Prijs (€)
4	1/8"	992X44M-4FF-1/8	48,14
4	1/4"	992X44M-4FF-1/4	49,44
6	1/8"	992X44M-6FF-1/8	55,84
6	1/4"	992X44M-6FF-1/4	54,86
6	3/8"	992X44M-6FF-3/8	54,95
8	1/8"	992X44M-8FF-1/8	64,55
8	1/4"	992X44M-8FF-1/4	65,16
8	3/8"	992X44M-8FF-3/8	66,05
10	1/4"	992X44M-10FF-1/4	76,79
10	3/8"	992X44M-10FF-3/8	77,10
10	1/2"	992X44M-10FF-1/2	80,36
12	1/4"	992X44M-12FF-1/4	101,16
12	3/8"	992X44M-12FF-3/8	101,42
12	1/2"	992X44M-12FF-1/2	103,29

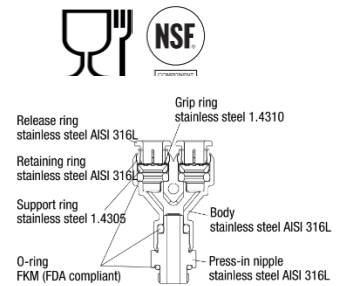
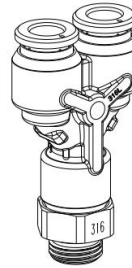

RVS opschroefkoppeling
PN 20 bar, T_{max} 140°C

Slang (mm)	Draad	Type	Prijs (€)
4	1/8"	946X44-4FF-1/8	14,68
4	1/4"	946X44-4FF-1/4	15,96
6	1/8"	946X44-6FF-1/8	15,95
6	1/4"	946X44-6FF-1/4	16,53
6	3/8"	946X44-6FF-3/8	17,22
8	1/8"	946X44-8FF-1/8	19,41
8	1/4"	946X44-8FF-1/4	20,42
8	3/8"	946X44-8FF-3/8	21,17
10	1/4"	946X44-10FF-1/4	26,58
10	3/8"	946X44-10FF-3/8	31,58
10	1/2"	946X44-10FF-1/2	35,37
12	1/4"	946X44-12FF-1/4	37,92
12	3/8"	946X44-12FF-3/8	41,60
12	1/2"	946X44-12FF-1/2	46,05

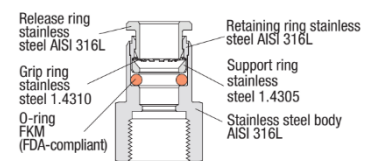
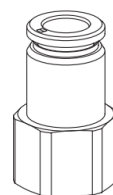

RVS knie inschroefkoppeling, conische schroefdraad, niet stelbaar
 PN 20 bar, T_{max} 140°C

Slang (mm)	Draad	Type	Prijs (€)
4	1/8"	950X44M-4FF-1/8K	15,78
4	1/4"	950X44M-4FF-1/4K	17,68
6	1/8"	950X44M-6FF-1/8K	16,73
6	1/4"	950X44M-6FF-1/4K	19,13
8	1/8"	950X44M-8FF-1/8K	23,86
8	1/4"	950X44M-8FF-1/4K	26,96
8	3/8"	950X44M-8FF-3/8K	30,59
10	1/4"	950X44M-10FF-1/4K	32,79
10	3/8"	950X44M-10FF-3/8K	33,90
10	1/2"	950X44M-10FF-1/2K	43,91
12	1/4"	950X44M-12FF-1/4K	44,32
12	3/8"	950X44M-12FF-3/8K	49,15
12	1/2"	950X44M-12FF-1/2K	51,52

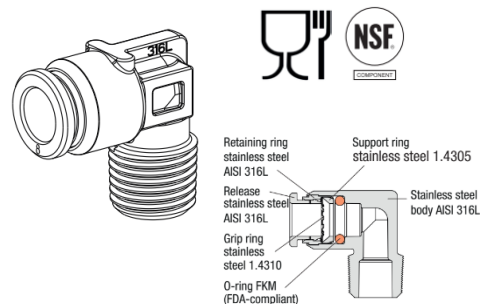

RVS knie inschroefkoppeling, cilindrische schroefdraad met FKM O-ring, stelbaar
 PN 16 bar, T_{max} 140°C

Slang (mm)	Draad	Type	Prijs (€)
4	M5	930X44M-4FF-M5	20,70
4	1/8"	930X44M-4FF-1/8	21,81
4	1/4"	930X44M-4FF-1/4	25,10
6	M5	930X44M-6FF-M5	22,22
6	1/8"	930X44M-6FF-1/8	23,28
6	1/4"	930X44M-6FF-1/4	26,08
6	3/8"	930X44M-6FF-3/8	28,21
8	1/8"	930X44M-8FF-1/8	27,91
8	1/4"	930X44M-8FF-1/4	29,54
8	3/8"	930X44M-8FF-3/8	33,13
10	1/4"	930X44M-10FF-1/4	37,08
10	3/8"	930X44M-10FF-3/8	44,67
10	1/2"	930X44M-10FF-1/2	47,51
12	1/4"	930X44M-12FF-1/4	51,83
12	3/8"	930X44M-12FF-3/8	54,40
12	1/2"	930X44M-12FF-1/2	58,48

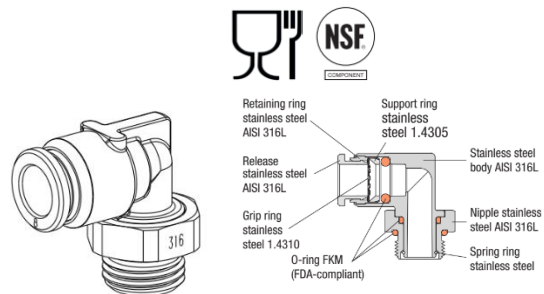

RVS knie insteker
 PN 20 bar, T_{max} 140°C

Slang (mm)	Type	Prijs (€)
4	911X44M-4FF-D4	20,38
6	911X44M-6FF-D6	22,98
8	911X44M-8FF-D8	27,79
10	911X44M-10FF-D10	33,12
12	911X44M-12FF-D12	41,61

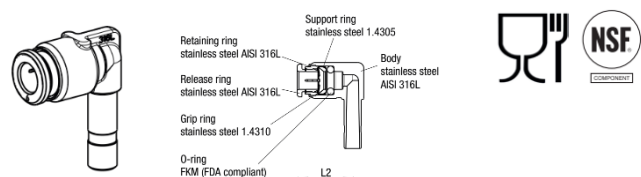

RVS Tee inschroefkoppeling, conische schroefdraad, niet stelbaar
 PN 20 bar, T_{max} 140°C

Slang (mm)	Draad	Type	Prijs (€)
4	1/8"	941X44M-4FF-1/8K	26,57
4	1/4"	941X44M-4FF-1/4K	30,40
6	1/8"	941X44M-6FF-1/8K	30,69
6	1/4"	941X44M-6FF-1/4K	33,42
8	1/8"	941X44M-8FF-1/8K	36,09
8	1/4"	941X44M-8FF-1/4K	39,68
8	3/8"	941X44M-8FF-3/8K	44,88
10	1/4"	941X44M-10FF-1/4K	50,58
10	3/8"	941X44M-10FF-3/8K	52,07
10	1/2"	941X44M-10FF-1/2K	55,16
12	1/4"	941X44M-12FF-1/4K	63,36
12	3/8"	941X44M-12FF-3/8K	65,41
12	1/2"	941X44M-12FF-1/2K	68,24

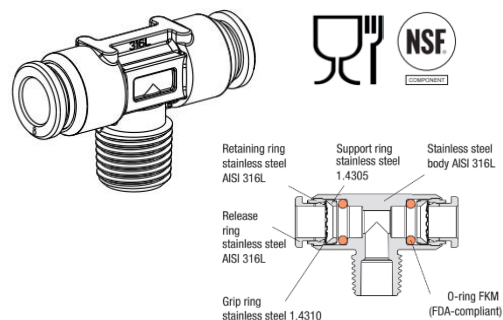

RVS Tee inschroefkoppeling, cilindrische schroefdraad met FKM O-ring, stelbaar
 PN 16 bar, T_{max} 140°C

Slang (mm)	Draad	Type	Prijs (€)
4	M5	921X44M-4FF-M5	27,91
4	1/8"	921X44M-4FF-1/8	29,13
4	1/4"	921X44M-4FF-1/4	33,22
6	M5	921X44M-6FF-M5	30,29
6	1/8"	921X44M-6FF-1/8	31,89
6	1/4"	921X44M-6FF-1/4	34,91
6	3/8"	921X44M-6FF-3/8	37,02
8	1/8"	921X44M-8FF-1/8	36,81
8	1/4"	921X44M-8FF-1/4	39,89
8	3/8"	921X44M-8FF-3/8	45,23
10	1/4"	921X44M-10FF-1/4	51,61
10	3/8"	921X44M-10FF-3/8	54,19
10	1/2"	921X44M-10FF-1/2	56,83
12	1/4"	921X44M-12FF-1/4	64,78
12	3/8"	921X44M-12FF-3/8	66,00
12	1/2"	921X44M-12FF-1/2	73,20

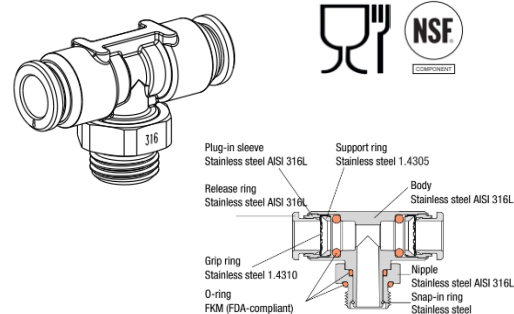

RVS Tee insteker
 PN 20 bar, T_{max} 140°C

Slang (mm)	Type	Prijs (€)
4	912X44M-4FF-D4	29,59
6	912X44M-6FF-D6	31,81
8	912X44M-8FF-D8	38,39
10	912X44M-10FF-D10	47,81
12	912X44M-12FF-D12	62,31

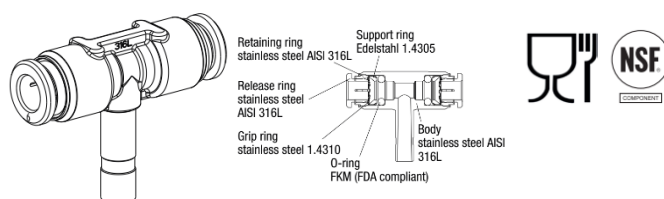

RVS Zij-tee inschroefkoppeling, cilindrische schroefdraad met FKM O-ring, stelbaar
 PN 16 bar, T_{max} 140°C

Slang (mm)	Draad	Type	Prijs (€)
4	1/8"	922X44M-4FF-1/8	51,30
4	1/4"	922X44M-4FF-1/4	52,60
6	1/8"	922X44M-6FF-1/8	57,94
6	1/4"	922X44M-6FF-1/4	56,97
6	3/8"	922X44M-6FF-3/8	57,05
8	1/8"	922X44M-8FF-1/8	63,92
8	1/4"	922X44M-8FF-1/4	64,52
8	3/8"	922X44M-8FF-3/8	65,41
10	1/4"	922X44M-10FF-1/4	75,70
10	3/8"	922X44M-10FF-3/8	76,02
10	1/2"	922X44M-10FF-1/2	79,27
12	1/4"	922X44M-12FF-1/4	111,68
12	3/8"	922X44M-12FF-3/8	111,94
12	1/2"	922X44M-12FF-1/2	113,82

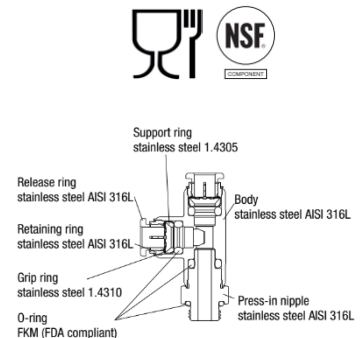
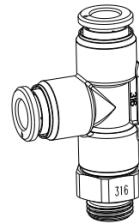

Rechte RVS Verbinder
 PN 20 bar, T_{max} 140°C

Slang-slang (mm-mm)	Type	Prijs (€)
4-4	958X44-4FF	17,79
4-6	958X44-6-4FF	19,99
6-6	958X44-6FF	18,43
6-8	958X44-8-6FF	22,24
8-8	958X44-8FF	20,55
8-10	958X44-10-8FF	25,59
10-10	958X44-10FF	23,54
10-12	958X44-12-10FF	33,78
12-12	958X44-12FF	31,09

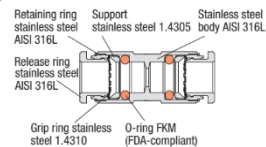
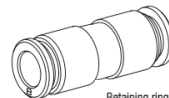

Knie RVS koppeling
 PN 20 bar, T_{max} 140°C

Slang (mm)	Type	Prijs (€)
4	955X44M-4FF	17,24
6	955X44M-6FF	20,31
8	955X44M-8FF	24,35
10	955X44M-10FF	31,77
12	955X44M-12FF	51,40

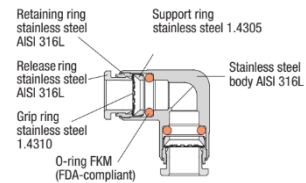
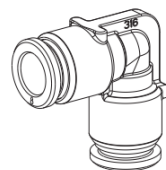

Tee RVS koppeling
 PN 20 bar, T_{max} 140°C

Slang (mm)	Type	Prijs (€)
4	954X44M-4FF	25,10
6	954X44M-6FF	27,94
8	954X44M-8FF	34,09
10	954X44M-10FF	43,34
12	954X44M-12FF	66,52

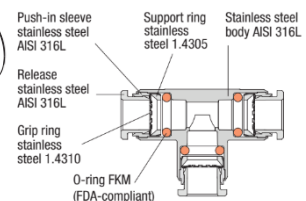
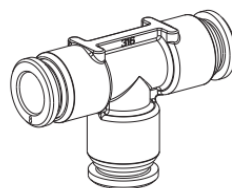

RVS insteek pen met cilindrische schroefdraad met FKM o-ring (FDA)

PN 20 bar, T_{max}140°C

Insteek (mm)	Draad	Type	Prijs (€)
4	M5	908X4-4FF-M5	10,39
4	1/8"	908X4-4FF-1/8	10,39
4	1/4"	908X4-4FF-1/4	11,73
6	M5	908X4-6FF-M5	9,85
6	1/8"	908X4-6FF-1/8	7,62
6	1/4"	908X4-6FF-1/4	9,58
6	3/8"	908X4-6FF-3/8	10,79
8	1/8"	908X4-8FF-1/8	7,83
8	1/4"	908X4-8FF-1/4	9,87
8	3/8"	908X4-8FF-3/8	11,09
10	1/4"	908X4-10FF-1/4	10,26
10	3/8"	908X4-10FF-3/8	11,45
10	1/2"	908X4-10FF-1/2	13,09
12	1/4"	908X4-12FF-1/4	11,96
12	3/8"	908X4-12FF-3/8	12,34
12	1/2"	908X4-12FF-1/2	13,98

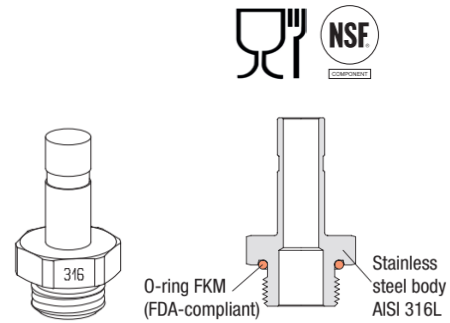

Dubbele RVS insteekpen

PN 20 bar, T_{max}140°C

Insteek (mm-mm)	Type	Prijs (€)
6-4	904X4-D6-D4	6,84
6-6	904X4-D6	4,74
8-6	904X4-D8-D6	5,96
8-8	904X4-D8	5,74
10-8	904X4-D10-D8	6,97
10-10	904X4-D10	6,73
12-10	904X4-D12-D10	8,65
12-12	904X4-D12	8,14

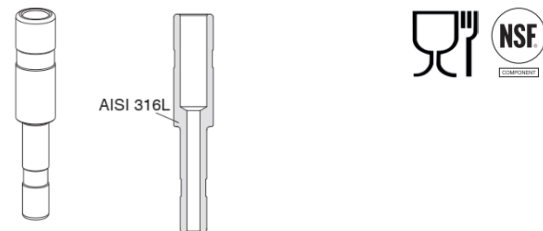

RVS schotdoorvoerkoppeling

PN 20 bar, T_{max}140°C

Slang (mm)	Type	Prijs (€)
4	959X44-4FF	26,92
6	959X44-6FF	33,43
8	959X44-8FF	36,42
10	959X44-10FF	40,28
12	959X44-12FF	43,95

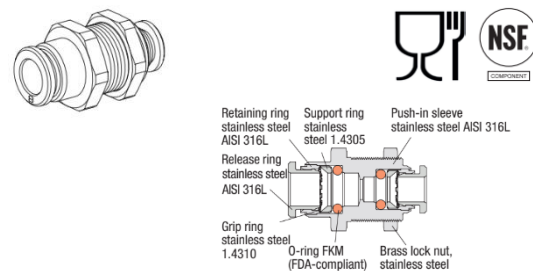

RVS Opschroef schotdoorvoerkoppeling

PN 20 bar, T_{max} 140°C

Slang (mm)	Draad	Type	Prijs (€)
4	1/8"	945X44-4FF-1/8	37,47
4	1/4"	945X44-4FF-1/4	48,00
6	1/8"	945X44-6FF-1/8	45,65
6	1/4"	945X44-6FF-1/4	46,66
6	3/8"	945X44-6FF-3/8	49,02
8	1/8"	945X44-8FF-1/8	52,14
8	1/4"	945X44-8FF-1/4	50,60
8	3/8"	945X44-8FF-3/8	52,26
10	1/4"	945X44-10FF-1/4	56,32
10	3/8"	945X44-10FF-3/8	56,46
10	1/2"	945X44-10FF-1/2	58,24
12	1/4"	945X44-12FF-1/4	64,39
12	3/8"	945X44-12FF-3/8	64,39
12	1/2"	945X44-12FF-1/2	65,14

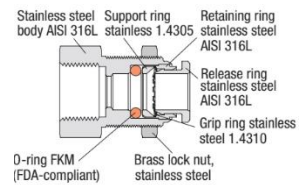
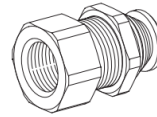

Rechte RVS inschroefkoppeling, cilindrische schroefdraad

Opsteekkoppeling RVS316L met **messing vernikkelde moer**, PN 25 bar, T_{max}140°C

Slang od/id (mm)	Draad	Type	Prijs (€)
6/4	1/8"	151X4-6/4M-1/8	7,87
6/4	1/4"	151X4-6/4M-1/4	8,17
8/6	1/8"	151X4-8/6M-1/8	8,28
8/6	1/4"	151X4-8/6M-1/4	8,57
10/8	1/8"	151X4-10/8M-1/8	9,07
10/8	1/4"	151X4-10/8M-1/4	9,43
10/8	3/8"	151X4-10/8M-3/8	11,11
12/10	1/4"	151X4-12/10M-1/4	10,64
12/10	3/8"	151X4-12/10M-3/8	15,83
12/10	1/2"	151X4-12/10M-1/2	19,42

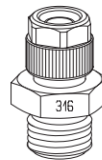

Rechte RVS inschroefkoppeling, conische schroefdraad

Opsteekkoppeling RVS316L met **messing vernikkelde moer**, PN 25 bar, T_{max}140°C

Slang od/id (mm)	Draad	Type	Prijs (€)
6/4	1/8"	151X4-6/4M-1/8K	7,87
6/4	1/4"	151X4-6/4M-1/4K	8,17
8/6	1/8"	151X4-8/6M-1/8K	8,28
8/6	1/4"	151X4-8/6M-1/4K	8,57
10/8	1/8"	151X4-10/8M-1/8K	9,07
10/8	1/4"	151X4-10/8M-1/4K	9,43
10/8	3/8"	151X4-10/8M-3/8K	11,11
12/10	3/8"	151X4-12/10M-3/8K	15,83
12/10	1/2"	151X4-12/10M-1/2K	19,42



RVS knie inschroefkoppeling, conische schroefdraad, niet stelbaar

Opsteekkoppeling RVS316L met **messing vernikkelde moer**, PN 25 bar, T_{max}140°C

Slang od/id (mm)	Draad	Type	Prijs (€)
6/4	1/8"	150X4M-6/4M-1/8K	13,09
6/4	1/4"	150X4M-6/4M-1/4K	16,46
8/6	1/8"	150X4M-8/6M-1/8K	16,06
8/6	1/4"	150X4M-8/6M-1/4K	17,74
8/6	3/8"	150X4-8/6M-3/8K	27,91
10/8	1/8"	150X4-10/8M-1/8K	23,45
10/8	1/4"	150X4-10/8M-1/4K	23,45
10/8	3/8"	150X4-10/8M-3/8K	28,09
12/10	3/8"	150X4-12/10M-3/8K	30,38
12/10	1/2"	150X4-12/10M-1/2K	33,98

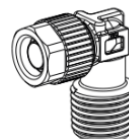

RVS knie inschroefkoppeling, cilindrische schroefdraad, stelbaar, FKM afdichting (FDA)
Opsteekkoppeling RVS316L met **messing vernikkelde moer**, PN 16 bar, T_{max}140°C

Slang od/id (mm)	Draad	Type	Prijs (€)
6/4	1/8"	130X4-6/4M-1/8FF	29,42
6/4	1/4"	130X4-6/4M-1/4FF	29,54
8/6	1/8"	130X4-8/6M-1/8FF	29,54
8/6	1/4"	130X4-8/6M-1/4FF	29,67
10/8	1/4"	130X4-10/8M-1/4FF	29,99

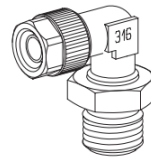

RVS knie inschroefkoppeling, conische schroefdraad, stelbaar, FKM afdichting (FDA)
Opsteekkoppeling RVS316L met **messing vernikkelde moer**, PN 16 bar, T_{max}140°C

Slang od/id (mm)	Draad	Type	Prijs (€)
6/4	1/8"	130X4-6/4M-1/8KFF	29,42
6/4	1/4"	130X4-6/4M-1/4KFF	29,54
8/6	1/8"	130X4-8/6M-1/8KFF	29,54
8/6	1/4"	130X4-8/6M-1/4KFF	29,67
10/8	1/4"	130X4-10/8M-1/4KFF	29,99

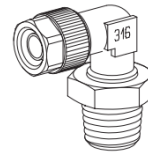

RVS Tee inschroefkoppeling, conische schroefdraad, niet stelbaar
Opsteekkoppeling RVS316L met **messing vernikkelde moeren**, PN 25 bar, T_{max}140°C

Slang od/id (mm)	Draad	Type	Prijs (€)
6/4	1/8"	141X4M-6/4M-1/8K	20,71
6/4	1/4"	141X4M-6/4M-1/4K	24,60
8/6	1/8"	141X4M-8/6M-1/8K	24,60
8/6	1/4"	141X4M-8/6M-1/4K	28,26
10/8	1/8"	141X4-10/8M-1/8K	35,40
10/8	1/4"	141X4-10/8M-1/4K	35,40
10/8	3/8"	141X4-10/8M-3/8K	42,37
12/10	3/8"	141X4-12/10M-3/8K	45,93
12/10	1/2"	141X4-12/10M-1/2K	52,17

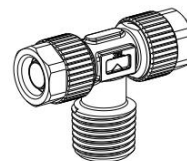

RVS Tee inschroefkoppeling, cilindrische schroefdraad, stelbaar, FKM afdichting (FDA)
Opsteekkoppeling RVS316L met **messing vernikkelde moeren**, PN 16 bar, T_{max}140°C

Slang od/id (mm)	Draad	Type	Prijs (€)
6/4	1/8"	121X4-6/4M-1/8FF	41,13
6/4	1/4"	121X4-6/4M-1/4FF	41,36
8/6	1/8"	121X4-8/6M-1/8FF	41,36
8/6	1/4"	121X4-8/6M-1/4FF	41,52
10/8	1/4"	121X4-10/8M-1/4FF	41,95

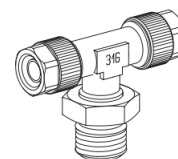

RVS Tee inschroefkoppeling, conische schroefdraad, stelbaar, FKM afdichting (FDA)
Opsteekkoppeling RVS316L met **messing vernikkelde moeren**, PN 16 bar, T_{max}140°C

Slang od/id (mm)	Draad	Type	Prijs (€)
6/4	1/8"	121X4-6/4M-1/8KFF	41,13
6/4	1/4"	121X4-6/4M-1/4KFF	41,36
8/6	1/8"	121X4-8/6M-1/8KFF	41,36
8/6	1/4"	121X4-8/6M-1/4KFF	41,52
10/8	1/4"	121X4-10/8M-1/4KFF	41,95

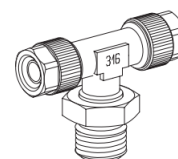

RVS Zij-tee inschroefkoppeling, conische schroefdraad, niet stelbaar

Opsteekkoppeling RVS316L met **messing vernikkelde moeren**, PN 25 bar, T_{max}140°C

Slang od/id (mm)	Draad	Type	Prijs (€)
6/4	1/8"	142X4-6/4M-1/8K	34,84
6/4	1/4"	142X4-6/4M-1/4K	34,84
8/6	1/8"	142X4-8/6M-1/8K	35,10
8/6	1/4"	142X4-8/6M-1/4K	35,10
10/8	1/8"	142X4-10/8M-1/8K	35,40
10/8	1/4"	142X4-10/8M-1/4K	35,40
10/8	3/8"	142X4-10/8M-3/8K	42,37

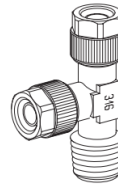

Knie koppeling

Opsteekkoppeling RVS316L met **messing vernikkelde moeren**, PN 25 bar, T_{max}140°C

Slang od/id (mm)	Type	Prijs (€)
6/4	155X4-6/4M	27,79
8/6	155X4-8/6M	28,15
10/8	155X4-10/8M	28,49
12/10	155X4-12/10M	32,42

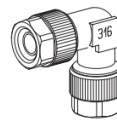

Tee koppeling

Opsteekkoppeling RVS316L met **messing vernikkelde moeren**, PN 25 bar, T_{max}140°C

Slang od/id (mm)	Type	Prijs (€)
6/4	154X4-6/4M	38,66
8/6	154X4-8/6M	39,24
10/8	154X4-10/8M	39,84
12/10	154X4-12/10M	53,93

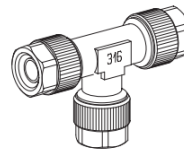

Rechte RVS inschroefkoppeling, cilindrische schroefdraad

Opsteekkoppeling RVS316L met **RVS 316L moer**, PN 25 bar, T_{max}140°C

Slang od/id (mm)	Draad	Type	Prijs (€)
6/4	1/8"	151X4-6/4-1/8	10,95
6/4	1/4"	151X4-6/4-1/4	11,24
8/6	1/8"	151X4-8/6-1/8	11,72
8/6	1/4"	151X4-8/6-1/4	12,00
10/8	1/8"	151X4-10/8-1/8	12,59
10/8	1/4"	151X4-10/8-1/4	12,99
10/8	3/8"	151X4-10/8-3/8	14,66
12/10	3/8"	151X4-12/10-3/8	19,26
12/10	1/2"	151X4-12/10-1/2	22,85

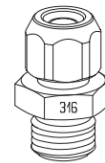

Rechte RVS inschroefkoppeling, conische schroefdraad

Opsteekkoppeling RVS316L met **RVS 316L moer**, PN 25 bar, T_{max}140°C

Slang od/id (mm)	Draad	Type	Prijs (€)
6/4	1/8"	151X4-6/4-1/8K	10,95
6/4	1/4"	151X4-6/4-1/4K	11,24
8/6	1/8"	151X4-8/6-1/8K	11,72
8/6	1/4"	151X4-8/6-1/4K	12,00
10/8	1/8"	151X4-10/8-1/8K	12,59
10/8	1/4"	151X4-10/8-1/4K	12,99
10/8	3/8"	151X4-10/8-3/8K	14,66
12/10	3/8"	151X4-12/10-3/8K	19,26
12/10	1/2"	151X4-12/10-1/2K	22,85

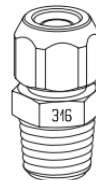

RVS knie inschroefkoppeling, conische schroefdraad, niet stelbaar

Opsteekkoppeling RVS316L met **RVS 316L moer**, PN 25 bar, T_{max}140°C

Slang od/id (mm)	Draad	Type	Prijs (€)
6/4	1/8"	150X4M-6/4-1/8K	16,37
6/4	1/4"	150X4M-6/4-1/4K	19,74
8/6	1/8"	150X4M-8/6-1/8K	19,54
8/6	1/4"	150X4M-8/6-1/4K	21,22
8/6	3/8"	150X4-8/6-3/8K	31,33
10/8	1/8"	150X4-10/8-1/8K	27,01
10/8	1/4"	150X4-10/8-1/4K	27,01
10/8	3/8"	150X4-10/8-3/8K	31,64
12/10	3/8"	150X4-12/10-3/8K	33,81
12/10	1/2"	150X4-12/10-1/2K	37,42

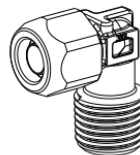

RVS knie inschroefkoppeling, cilindrische schroefdraad, stelbaar, FKM afdichting (FDA)
Opsteekkoppeling RVS316L met **RVS 316L moer**, PN 16 bar, T_{max}140°C

Slang od/id (mm)	Draad	Type	Prijs (€)
6/4	1/8"	130X4-6/4-1/8FF	32,44
6/4	1/4"	130X4-6/4-1/4FF	32,57
8/6	1/8"	130X4-8/6-1/8FF	32,97
8/6	1/4"	130X4-8/6-1/4FF	33,09
10/8	1/4"	130X4-10/8-1/4FF	33,54

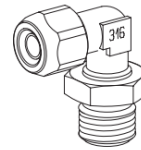

RVS knie inschroefkoppeling, conische schroefdraad, stelbaar, FKM afdichting (FDA)
Opsteekkoppeling RVS316L met **RVS 316L moer**, PN 16 bar, T_{max}140°C

Slang od/id (mm)	Draad	Type	Prijs (€)
6/4	1/8"	130X4-6/4-1/8KFF	32,44
6/4	1/4"	130X4-6/4-1/4KFF	32,57
8/6	1/8"	130X4-8/6-1/8KFF	32,97
8/6	1/4"	130X4-8/6-1/4KFF	33,09
10/8	1/4"	130X4-10/8-1/4KFF	33,54

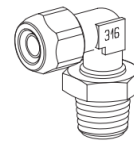

RVS Tee inschroefkoppeling, conische schroefdraad, niet stelbaar
Opsteekkoppeling RVS316L met **RVS 316L moeren**, PN 25 bar, T_{max}140°C

Slang od/id (mm)	Draad	Type	Prijs (€)
6/4	1/8"	141X4M-6/4-1/8K	27,27
6/4	1/4"	141X4M-6/4-1/4K	31,14
8/6	1/8"	141X4M-8/6-1/8K	31,53
8/6	1/4"	141X4M-8/6-1/4K	35,20
10/8	1/8"	141X4-10/8-1/8K	42,51
10/8	1/4"	141X4-10/8-1/4K	42,51
10/8	3/8"	141X4-10/8-3/8K	49,48
12/10	3/8"	141X4-12/10-3/8K	52,80
12/10	1/2"	141X4-12/10-1/2K	59,03

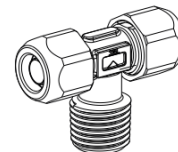

RVS Tee inschroefkoppeling, cilindrische schroefdraad, stelbaar, FKM afdichting (FDA)
Opsteekkoppeling RVS316L met **RVS 316 L moeren**, PN 16 bar, T_{max}140°C

Slang od/id (mm)	Draad	Type	Prijs (€)
6/4	1/8"	121X4-6/4-1/8FF	47,20
6/4	1/4"	121X4-6/4-1/4FF	47,47
8/6	1/8"	121X4-8/6-1/8FF	48,21
8/6	1/4"	121X4-8/6-1/4FF	48,37
10/8	1/4"	121X4-10/8-1/4FF	49,04

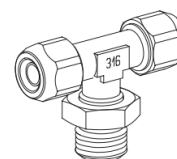

RVS Tee inschroefkoppeling, conische schroefdraad, stelbaar, FKM afdichting (FDA)
Opsteekkoppeling RVS316L met **RVS 316 L moeren**, PN 16 bar, T_{max}140°C

Slang od/id (mm)	Draad	Type	Prijs (€)
6/4	1/8"	121X4-6/4-1/8KFF	47,20
6/4	1/4"	121X4-6/4-1/4KFF	47,47
8/6	1/8"	121X4-8/6-1/8KFF	48,21
8/6	1/4"	121X4-8/6-1/4KFF	48,37
10/8	1/4"	121X4-10/8-1/4KFF	49,04

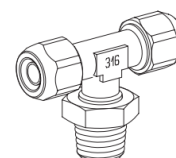

RVS Zij-tee inschroefkoppeling, conische schroefdraad, niet stelbaar
Opsteekkoppeling RVS316L met **RVS 316 L moeren**, PN 25 bar, T_{max} 140°C

Slang od/id (mm)	Draad	Type	Prijs (€)
6/4	1/8"	142X4-6/4-1/8K	40,92
6/4	1/4"	142X4-6/4-1/4K	40,92
8/6	1/8"	142X4-8/6-1/8K	41,97
8/6	1/4"	142X4-8/6-1/4K	41,97
10/8	1/8"	142X4-10/8-1/8K	42,51
10/8	1/4"	142X4-10/8-1/4K	42,51
10/8	3/8"	142X4-10/8-3/8K	49,48

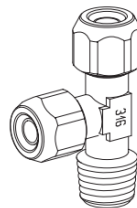

Knie koppeling

Opsteekkoppeling RVS316L met **RVS 316 L moeren**, PN 25 bar, T_{max} 140°C

Slang od/id (mm)	Type	Prijs (€)
6/4	155X4-6/4	33,85
8/6	155X4-8/6	35,01
10/8	155X4-10/8	35,57
12/10	155X4-12/10	39,28

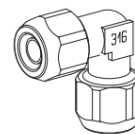

Tee koppeling

Opsteekkoppeling RVS316L met **RVS 316 L moeren**, PN 25 bar, T_{max} 140°C

Slang od/id (mm)	Type	Prijs (€)
6/4	154X4-6/4	47,82
8/6	154X4-8/6	49,55
10/8	154X4-10/8	50,49
12/10	154X4-12/10	57,38

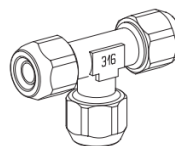

RVS 316L slangpilaar met cilindrische schroefdraad met FKM o-ring (FDA)
PN 25 bar, T_{max}140°C

Slang (mm)	Draad	Type	Prijs (€)
3,5-4	M5	260X4-4-M5FF	7,09
5-6	1/8"	260X4-7-1/8FF	7,09
5-6	1/4"	260X4-7-1/4FF	8,75
6-7	1/8"	260X4-8-1/8FF	7,09
6-7	1/4"	260X4-8-1/4FF	8,75
7-8	1/8"	260X4-9-1/8FF	7,09
7-8	1/4"	260X4-9-1/4FF	8,75
7-8	3/8"	260X4-9-3/8FF	10,40
9-10	1/4"	260X4-10-1/4FF	8,75
10-11	1/4"	260X4-12-1/4FF	8,75
10-11	3/8"	260X4-12-3/8FF	10,40
10-11	1/2"	260X4-12-1/2FF	19,79
12-13	1/4"	260X4-14-1/4FF	9,03
12-13	3/8"	260X4-14-3/8FF	10,40
12-13	1/2"	260X4-14-1/2FF	19,79
15-16	3/8"	260X4-17-3/8FF	10,96
15-16	1/2"	260X4-17-1/2FF	20,82
18-19	1/2"	260X4-20-1/2FF	20,82

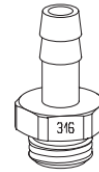

RVS 316L dubbele nippel, cilindrische schroefdraad, met FKM o-ringen (FDA)
PN 25 bar, T_{max}140°C

Draad	Type	Prijs (€)
1/8"	250X4-1/8FF	8,66
1/4"	250X4-1/4FF	10,49
3/8"	250X4-3/8FF	11,47
1/2"	250X4-1/2FF	18,29



RVS 316L dubbele nippel, conische schroefdraad
PN 25 bar, T_{max}140°C

Draad	Type	Prijs (€)
1/8"	250X4-1/8K	5,42
1/4"	250X4-1/4K	6,76
3/8"	250X4-3/8K	12,04
1/2"	250X4-1/2K	18,00



RVS 316L verloopnippel, cilindrische schroefdraad, met FKM o-ringen (FDA)
PN 25 bar, T_{max}140°C

Draad1	Draad2	Type	Prijs (€)
1/8"	1/4"	251X4-1/8-1/4FF	10,11
1/8"	3/8"	251X4-1/8-3/8FF	11,45
1/8"	1/2"	251X4-1/8-1/2FF	17,24
1/4"	3/8"	251X4-1/4-3/8FF	21,59
1/4"	1/2"	251X4-1/4-1/2FF	17,73
3/8"	1/2"	251X4-3/8-1/2FF	18,13



RVS 316L verloopnippel, conische schroefdraad
PN 25 bar, T_{max}140°C

Draad1	Draad2	Type	Prijs (€)
1/8"	1/4"	251X4-1/8K-1/4K	6,50
1/8"	3/8"	251X4-1/8K-3/8K	7,68
1/8"	1/2"	251X4-1/8K-1/2K	16,80
1/4"	3/8"	251X4-1/4K-3/8K	8,09
1/4"	1/2"	251X4-1/4K-1/2K	17,49
3/8"	1/2"	251X4-3/8K-1/2K	17,56



RVS 316L reduceernippel, cilindrische buitendraad met FKM o-ring (FDA)
PN 25 bar, T_{max}140°C

Buiten draad	Binnen Draad	Type	Prijs (€)
1/8"	1/8"	252X4-1/8FF-1/8	6,75
1/8"	1/4"	252X4-1/8FF-1/4	8,38
1/8"	3/8"	252X4-1/8FF-3/8	14,11
1/8"	1/2"	252X4-1/8FF-1/2	18,02
1/4"	1/4"	252X4-1/4FF-1/4	8,57
1/4"	3/8"	252X4-1/4FF-3/8	14,35
1/4"	1/2"	252X4-1/4FF-1/2	18,36
3/8"	3/8"	252X4-3/8FF-3/8	14,68
3/8"	1/2"	252X4-3/8FF-1/2	18,58
1/2"	1/2"	252X4-1/2FF-1/2	18,69



RVS 316L reduceernippel, conische buitendraad
PN 25 bar, T_{max}140°C

Buiten draad	Binnen Draad	Type	Prijs (€)
1/8"	1/8"	252X4-1/8K-1/8	6,38
1/8"	1/4"	252X4-1/8K-1/4	8,08
1/8"	3/8"	252X4-1/8K-3/8	13,98
1/8"	1/2"	252X4-1/8K-1/2	17,96
1/4"	1/4"	252X4-1/4K-1/4	8,45
1/4"	3/8"	252X4-1/4K-3/8	14,37
1/4"	1/2"	252X4-1/4K-1/2	18,65
3/8"	3/8"	252X4-3/8K-3/8	14,58
3/8"	1/2"	252X4-3/8K-1/2	18,72
1/2"	1/2"	252X4-1/2K-1/2	19,27

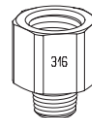

RVS 316L verloopring, cilindrische buitendraad met FKM o-ring (FDA)
PN 25 bar, T_{max}140°C

Buiten draad	Binnen Draad	Type	Prijs (€)
1/4"	1/8"	253X4-1/4FF-1/8	6,22
3/8"	1/8"	253X4-3/8FF-1/8	7,80
1/2"	1/8"	253X4-1/2FF-1/8	15,83
3/8"	1/4"	253X4-3/8FF-1/4	8,22
1/2"	1/4"	253X4-1/2FF-1/4	15,83
1/2"	3/8"	253X4-1/2FF-3/8	15,83



RVS 316L verloopring, conische buitendraad
PN 25 bar, T_{max}140°C

Buiten draad	Binnen Draad	Type	Prijs (€)
1/4"	1/8"	253X4-1/4K-1/8	6,22
3/8"	1/8"	253X4-3/8K-1/8	7,15
1/2"	1/8"	253X4-1/2K-1/8	15,45
3/8"	1/4"	253X4-3/8K-1/4	7,58
1/2"	1/4"	253X4-1/2K-1/4	15,45
1/2"	3/8"	253X4-1/2K-3/8	15,45



RVS 316L Sok
PN 25 bar, T_{max}140°C

Draad	Type	Prijs (€)
1/8"	254X4-1/8	5,96
1/4"	254X4-1/4	8,19
3/8"	254X4-3/8	12,52
1/2"	254X4-1/2	18,46



RVS 316L verloopsok
PN 25 bar, T_{max}140°C

Draad1	Draad2	Type	Prijs (€)
1/8"	1/4"	255X4-1/8-1/4	9,31
1/8"	3/8"	255X4-1/8-3/8	10,90
1/8"	1/2"	255X4-1/8-1/2	17,40
1/4"	3/8"	255X4-1/4-3/8	11,53
1/4"	1/2"	255X4-1/4-1/2	17,84
3/8"	1/2"	255X4-3/8-1/2	17,84



RVS 316L plug, cilindrische schroefdraad, met FKM o-ring (FDA)
PN 25 bar, T_{max}140°C

Draad	Type	Prijs (€)
1/8"	262X4-1/8FF	5,13
1/4"	262X4-1/4FF	6,13
3/8"	262X4-3/8FF	6,56
1/2"	262X4-1/2FF	9,50



PFA Slangen

Perfluoralkoxy, excellente chemische eigenschappen
 Intrinsiek bestand tegen licht, hitte en veroudering
 Intrinsiek zelfdovend (UL94 V0)
 Temperatuur bereik -60°C tot +260°C
 Geschikt voor insteekkoppelingen

Uitw. (mm)	Inw. (mm)	Buigradius (mm)	Max. druk Bij 23°C (bar)	Type:	Prijs(€): Per meter
4	2	15	30	PFA4X2-N	6,23
6	4	30	18	PFA6X4-N	8,89
8	6	50	12	PFA8X6-N	10,60
10	8	80	10	PFA10X8-N	13,40
12	10	115	8	PFA12X10-N	17,22

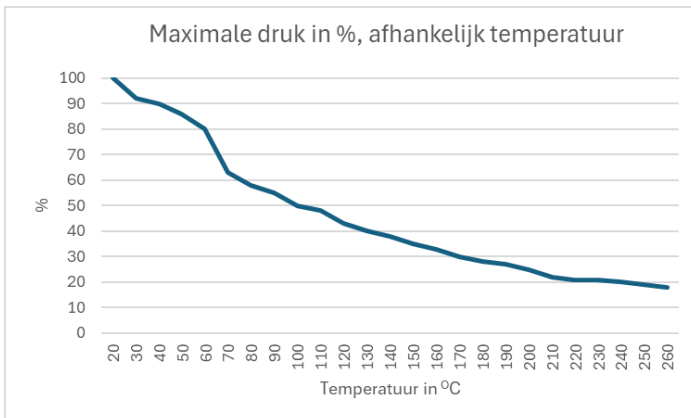

Kleur: transparant

Leverbaar op rollen van 25, 50 en 100 meter (op basis beschikbaarheid).

Andere afmetingen op aanvraag.

FEP Slangen

Fluorinated ethylene propylene, excellente chemische eigenschappen
 Intrinsiek bestand tegen licht, hitte en veroudering
 Intrinsiek zelfdovend (UL94 V0)
 Temperatuur bereik -40°C tot +200°C
 Geschikt voor insteekkoppelingen



Uitw. (mm)	Inw. (mm)	Buigradius (mm)	Max. druk Bij 23°C (bar)	Type:	Prijs(€): Per meter
4	2	15	30	FEP4X2-N	4,80
6	4	40	18	FEP6X4-N	6,31
8	6	70	12	FEP8X6-N	7,17
10	8	110	10	FEP10X8-N	8,25
12	10	160	8	FEP12X10-N	9,89

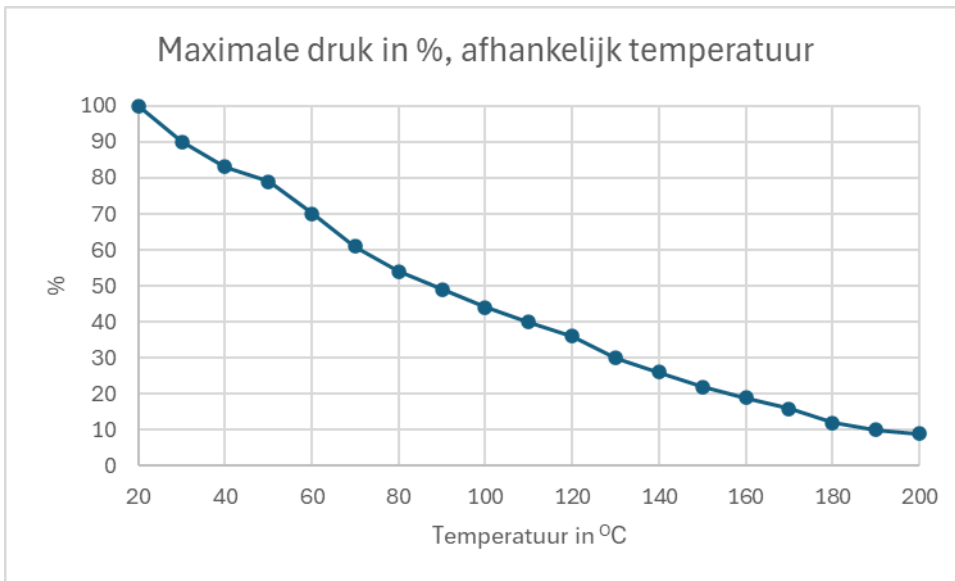

Kleur: transparant

Leverbaar op rollen van 25, 50 en 100 meter (op basis beschikbaarheid).

Andere afmetingen op aanvraag.

PVDF2800 (kynar) slangen

Vinylidene polyfluoride, excellente chemische eigenschappen
 Intrinsiek bestand tegen licht, hitte en veroudering
 Intrinsiek zelfdovend (UL94 V0)
 Food kwaliteit optioneel.
 Temperatuur bereik -40°C tot +90°C
 Geschikt voor insteekkoppelingen

Uitw. (mm)	Inw. (mm)	Buigradius (mm)	Max. druk Bij 23°C (bar)	Type:	Prijs(€): Per meter
4	2,5	25	38	KY4X2,5-N	1,98
6	4	40	33	KY6X4-N	4,17
8	6	70	23	KY8X6-N	5,77
10	8	110	18	KY10X8-N	7,67
12	10	160	15	KY12X10-N	9,01

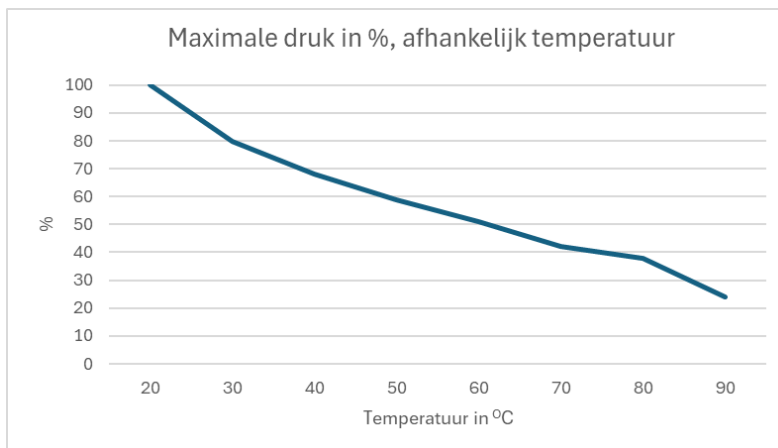

Kleur: semi-transparant. Zwart, blauw en rood op aanvraag

Leverbaar op rollen van 25, 50 en 100 meter (op basis beschikbaarheid).

Andere afmetingen op aanvraag.

Food grade op aanvraag.

Deze prijslijst is met grote zorgvuldigheid samengesteld. Alle voorbeelden, prijzen en alle overige informatie is onder voorbehoud van fouten en wijzigingen.