

2/2-Way Valve - Type PGV Series 200 - Pressure Operated (Volume Booster) by External Medium

Price group 53	Function "B" normally open	low noise and impact-free closing, for neutral, gaseous and fluids	Brass							
Version	Control-pressure [bar]	DN	Kv-value water [m³/h]	G	PN	Sealing material	Type (Partial solenoid valve without solenoid coils)	Order number	Price	
 <p>2/2-way valve pressure operated, double-sided blocking by external medium</p> <p>Permitted operating pressure 0.3 to 16 bar</p> <p>Further features Page <AE></p>	\geq excess operating pressure max. 16	10	2	G 3/8	16	NBR	PGV-231 -B77-3/8BP	614041	o. r.	
		10	2	G 3/8	16	EPDM	PGV-231 -B77-3/8PP	614043	o. r.	
		10	2	G 3/8	16	FKM	PGV-231 -B77-3/8FP	614045	o. r.	
		12	2.2	G 1/2	16	NBR	PGV-231 -B77-1/2BP	614051	o. r.	
		12	2.2	G 1/2	16	EPDM	PGV-231 -B77-1/2PP	614053	o. r.	
		12	2.2	G 1/2	16	FKM	PGV-231 -B77-1/2FP	614055	o. r.	

Illustration

Remotely operated 2/2-way valve regulated by external medium with 3/2-way valve (positive control)

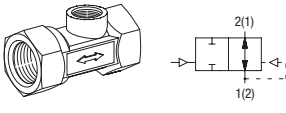
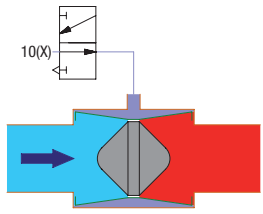

Remotely operated 2/2-way valve regulated by external medium with 2/2-way valve

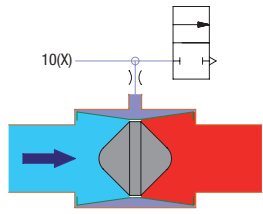

Remotely operated excess pressure valve regulated by external medium with pressure regulator

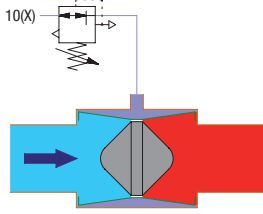

2/2-Way Valve - Type PGV Series 200 - Pressure Operated (Volume Booster) by Own Medium

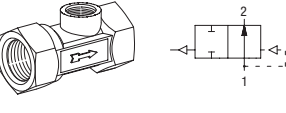
Price group 53	Function "B" normally open (without control pressure)	low noise and impact-free closing, for neutral, gaseous and fluids	Brass							
Version	Control-pressure [bar]	DN	Kv-value water [m³/h]	G	PN	Sealing material	Type (Partial solenoid valve without solenoid coils)	Order number	Price	
 <p>2/2-way valve pressure operated, by own medium</p> <p>Permitted operating pressure 0.3 to 16 bar</p>	\geq excess operating pressure max. 16	10	2	G 3/8	16	NBR	PGV-231-B77-3/8BN	614095	o. r.	
		10	2	G 3/8	16	EPDM	PGV-231-B77-3/8PN	614073	o. r.	
		10	2	G 3/8	16	FKM	PGV-231-B77-3/8FN	614075	o. r.	
		12	2.2	G 1/2	16	NBR	PGV-231-B77-1/2BN	614081	o. r.	
		12	2.2	G 1/2	16	EPDM	PGV-231-B77-1/2PN	614083	o. r.	
		12	2.2	G 1/2	16	FKM	PGV-231-B77-1/2FN	614085	o. r.	

Illustration

Remotely operated 2/2-way valve regulated by own medium with 2/2-way valve (negative control)

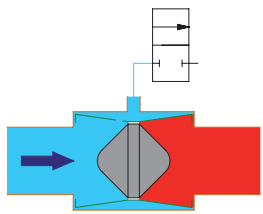

Remotely operated 2/2-way valve regulated by own medium with 2/2-way valve (control medium recycled)

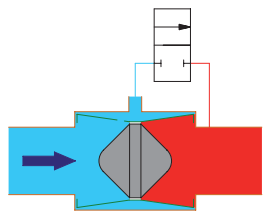

Remotely operated pressure regulator valve regulated by own medium with pressure regulator (control medium recycled)

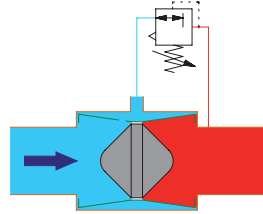
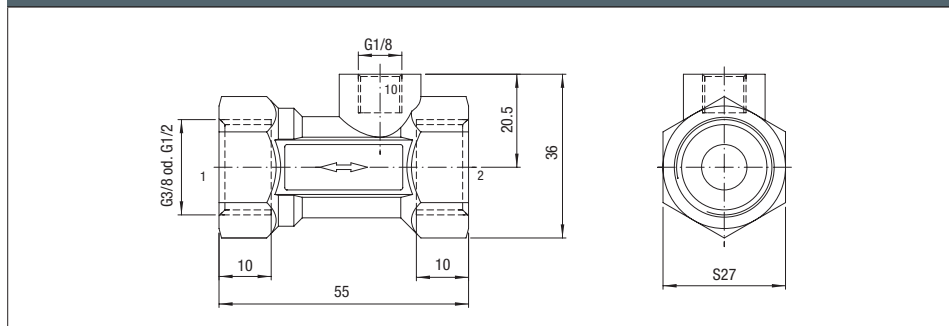

Illustration

Options

Brass components chemically nickel-plated

increases resistance to corrosion and replaces stainless steel valves cost-effectively for many flow media
Type PGV-231Q-...